

Lid Top View

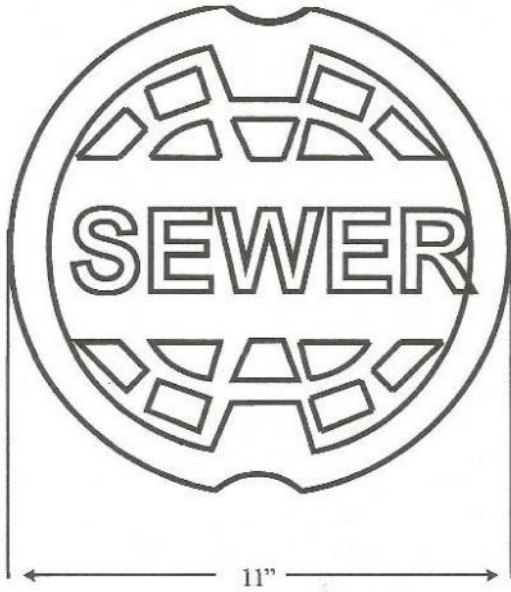

Lid Side View

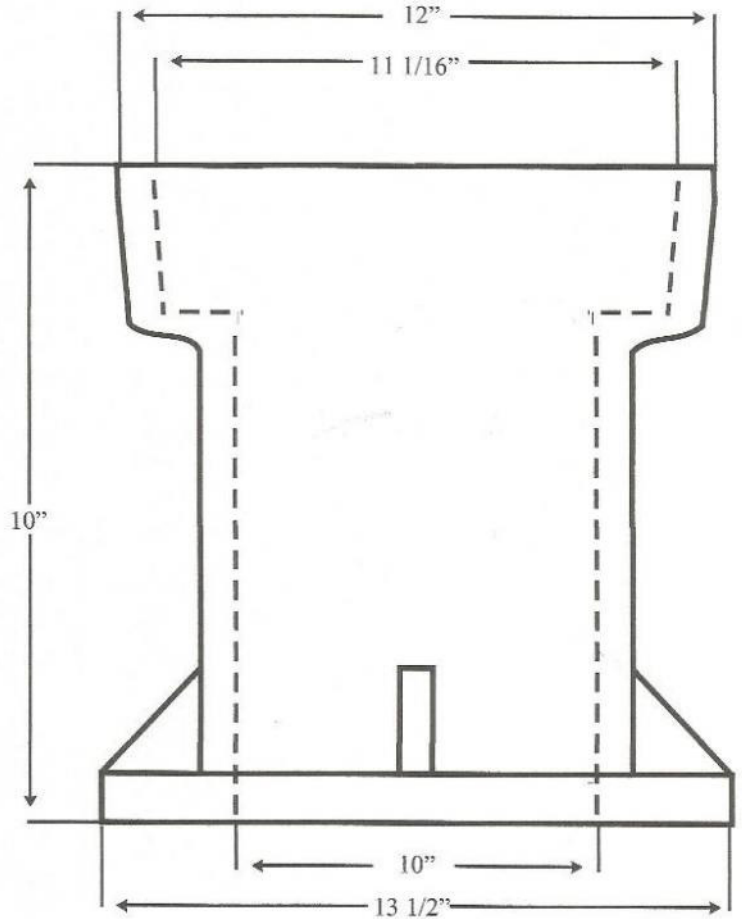
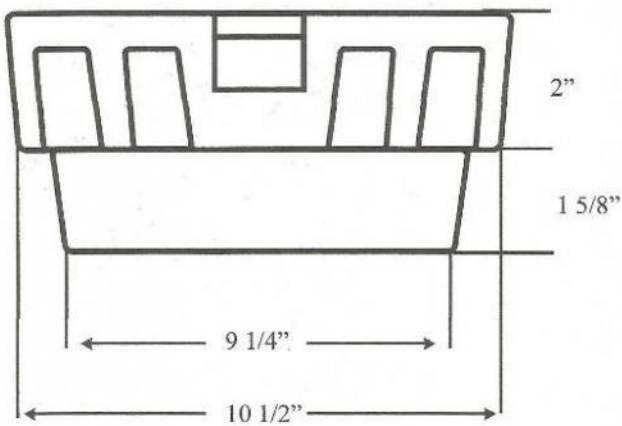

Figure # SC80 10" Roadway Sewer Cleanout 10" High

Casting conforms to:
ASTM specifications A-48 Class 30

Certified Tested to exceed
H-20 Load Test Rating

CP Test & Valvco, Inc.
201-998-1500
www.cptest.com